



---

# Research on the Application of NLP-Driven Opinion Sentiment Tendency Analysis in Precision Marketing of New Energy Vehicles

Na Tang<sup>1\*</sup>, Li Daijie<sup>2</sup>, Bu mulang<sup>3</sup>, Liu Zhongyuan<sup>4</sup>, Zhu Wenjing<sup>5</sup>, Yang Chuanxiang<sup>6</sup>

<sup>1,2,3,4,5,6</sup>School of Business, Geely University of China, Chengdu, Sichuan, China

---

## Article Information

Received: 21-11-2024

Revised: 28-11-2024

Published: 05-12-2024

## Keywords

*NLP-Driven; Online New Media Era*

*;New Nenergy;*

## \*Correspondence Email:

*tangna@guc.edu.cn*

## Abstract

In today's online new media era, online public opinion often influences consumers' purchasing decisions. This dissertation discusses the strategies to promote the development of domestic new energy passenger cars, and combines the comment data of major media platforms, so that enterprises can more accurately understand the public's attitudes and perceptions towards new energy vehicles, and formulate more effective marketing strategies to increase the sales of new energy vehicles. This paper utilizes the nlp sentiment analysis technique, and incorporates 15 original papers to collect nearly 20,000 comments from major websites. It is found that the sales of new energy vehicles continue to rise despite a high proportion of negative online opinions about new energy vehicles, which is closely related to scientific and technological innovations, policy promotion, and consumers' increased acceptance of the concept of green mobility.

---

## 1. Introduction

Since the new century, the rapid development of China's new energy industry, represented by new energy vehicles, has demonstrated the good momentum of China's industrial upgrading and the strong resilience of the economy. China's new energy vehicle production and sales have been the world's first for nine consecutive years since 2015, and it is one of the new industrial tracks with the most rapid growth and the best development prospects for the new energy industry. However, although the new energy vehicle manufacturing in recent years has obvious improvements in environmental protection and energy saving, it still attracts a lot of attention in terms of battery decay, slow charging speed, high maintenance costs, etc., which has caused the majority of users to conduct extensive public opinion discussions on new media platforms, such as Jitterbug, Xiaohongshu, Weibo, and Automotive House on the relevant performance, range, charging facilities, and after-sales service of new energy vehicles. This has reduced users' brand perception of new energy vehicles and affected the marketing strategies of automobile companies.

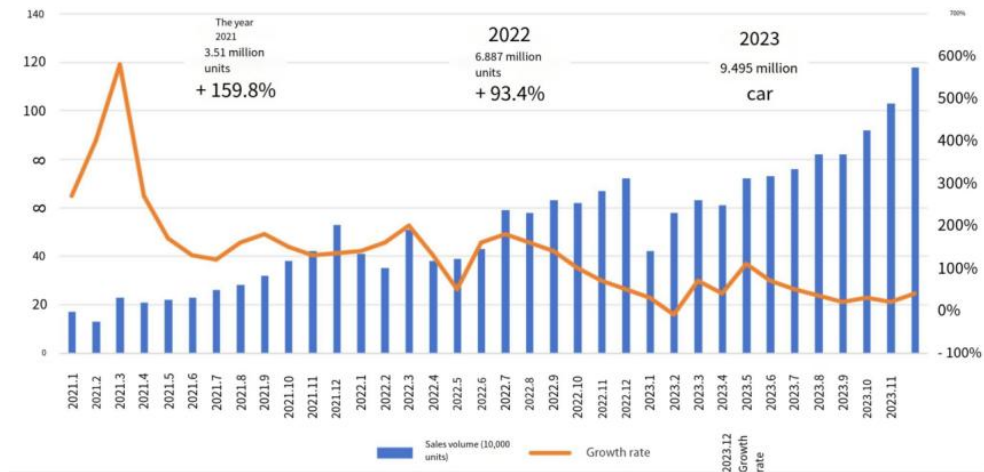

Fig 1. New Energy Vehicle Monthly Sales and Growth Rate Chart

It can be seen that in today's online new media era, online public opinion often influences consumers' purchasing decisions. The thesis will analyze the NLP natural language analysis by collecting user comments on several mainstream video platforms and professional automotive websites, including but not limited to Jitterbug, Bilibili, and other major video websites, as well as professional automotive information and forum websites such as Automotive House, and specifically analyze the impact on the new energy vehicles by combining the brand positioning, publicity, policies, and the public awareness, i.e., the specific implementation of the concept of green environmental protection, and so on. The influence of public opinion orientation is specifically analyzed. Based on the above research and analysis, we discuss the relevant strategies to promote the development of domestic new energy passenger cars, so that enterprises can more accurately understand the public's attitudes and views on new energy vehicles, formulate more effective marketing strategies, enhance brand image, so as to achieve the purpose of enhancing customer satisfaction.

This dissertation not only can theoretically validate the previous work, but also analyzes the emotional tendency of online users' comment data with the help of network data collection technology and NLP technology, quantifies the trend of public opinion, verifies the operability of the technology, and enriches the research literature of new energy automobile on public opinion; and practically, it helps the automobile company to formulate a more effective marketing strategy, and improves the brand influence and user perception of the automobile company, and then leads to commercial profitability. company's brand influence and user perception, which in turn leads to commercial profitability.

### 1.1 Literature Review

In the era of online new media, online public opinion affects consumers' consumption behavior. Chen Jing believes that digital media represented by the Internet and social media provide consumers with rich information acquisition channels and consumption methods [Chen, J.]. Mainstream online media platforms use big data technology to collect and analyze user information, understand consumers' daily preferences, and accurately push corresponding content for them to guide consumer consumption. Fang Fusheng believes that more valuable information can be obtained from the massive information, and through the collection and organization of this valuable information, it can better serve the enterprise marketing work [Fang, F.]. For example, mainstream short video platforms such as Jittery and Shutterbug use big data technology to collect information, with precise promotion of user-interested content as the main business strategy.

## Overview of NLP Sentiment Analysis Techniques

NLP is an important direction in the field of artificial intelligence and computers, which is used to study the methods and theories of effective communication between humans and computers in natural language. Jia Guosheng believes that NLP sentiment analysis technology in the economic field can help businessmen to understand consumers' evaluation of products and promote the improvement of products to make them more in line with consumers' needs [Jia, G.]. Sentiment analysis, as the core field of NLP, can help us explore the subjective emotions of text, and Chen Siyuan believes that NLP technology can not only analyze the literal meaning of text, but also analyze the emotional tendency behind the literal meaning [Chen, S.]. Analyzing the emotional orientation of consumers towards the product increases the market value of the product for the enterprise.

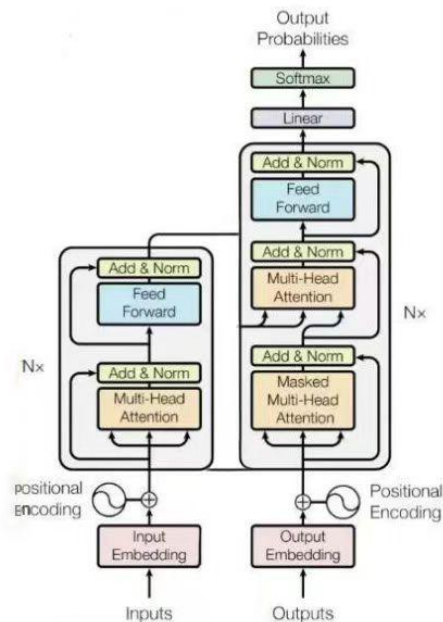

Fig. 2 NLP Technology Pathway Diagram (left half is the main part)

This paper is a nlp task-sentiment analysis based on transformer, using transformer architecture, because the task is text categorization so only the encoder part of the architecture is quoted, as demonstrated by the left part of the figure, the model uses consumer evaluation of new energy vehicles as input Embedding, NLP Sentiment analysis technology is used as Positional Encoding to analyze consumer evaluation. Various new media network platforms act as Multi-Head Attention to provide more data support for the final Output. It shows the important role of NLP Sentiment Analysis to promote consumer consumption.

## Research status

NLP is an important direction in the process of the development of new energy automobile industry, not only the research on new energy automobile technology and policy, but also scholars focus on the impact of NLP sentiment analysis on the development of new energy automobile. Song Chunyan believes that in-depth analysis of consumer behavioral characteristics can provide enterprises with precise market insights and market dynamics to further optimize marketing strategies and market positioning [Song, C.]. Hou Heshui believes that with the optimization of the dimension and system of consumer reviews, user reviews also have a more in-depth reference value [Hou, H.]. Based on the former study, it is found that Song Chunyan only analyzes the emotional attitude of consumers, and Hou Heshui only focuses on the analysis of consumers' willingness to buy, and both of them only stay under the influence of public opinion on consumers, and the analysis of the perception and response of automobile enterprises to user reviews is relatively insufficient.

## heoretical foundation

This study uses the AISAS model as the analytical model: Attention (Attention-getting) Han Mengdi believes that the marketing means proposed by the enterprise for the corresponding market can help the enterprise to increase the brand influence and market share [Han, M.]. Through a variety of marketing means, such as through creative advertising to show the appearance of new energy vehicles and other advantages or the use of celebrity influence to increase product exposure, so that consumers notice the brand or product information, so that it stands out from the mass of products, to cause consumers or potential consumers to pay attention; Interest (cause interest) Jia Jia to explore the phenomenon of different attention of consumers to different visual complexity of the commodity attribute area. Jia Jia explored the phenomenon that consumers pay different attention to different visual complexity product attribute areas [Jia, J.]. Found that want to attract the attention of consumers is extremely difficult, so the marketing tools are extremely important to attract the attention of consumers to further show consumers the advantages, features, unique value of the product, such as new energy vehicles, environmental protection and energy saving, intelligent driving systems and other content to stimulate consumer interest; Search (search) Long Liujiang pointed out that rational consumers will carry out a pre-purchase search for information to ensure that the purchase of the product for their own benefit, and to ensure that the purchase of the product for their own benefit, and to ensure that the purchase of the product for their own utility [Long, L.]. So when consumers are interested in the product they want to know more about, they will search for more details about the product, brand through search engines, social media and other channels, consumers will focus on car performance, user reviews, after-sales service and other aspects of the comparison, in order to make a more informed choice to buy; Action (take action) Wang Ying believes that the media conveyed information deep into the hearts of consumers, can effectively hit the consumer's heart. Wang Ying believes that the information conveyed by the media can effectively persuade consumers by penetrating deeply into their hearts [Wang, Y.]. Consumers will choose to buy products that meet their expectations according to their own needs after understanding and consideration. New media marketing provides consumers with a more convenient consumption channel through online and offline interaction and integration, and promotes purchasing by organizing preferential activities, financial loans and other programs; Share Wang Xilian points out that under the current communication pattern in which the new media is the main communication channel, consumers' behaviors not only include information acquisition and purchasing behavior, but also the behavior of consumers. Including information acquisition, purchase behavior, but also the use of multiple channels to share brand word of mouth, it is necessary to include it in the evaluation system [Han, M.]. After purchasing and using, consumers often share their feelings on new media channels such as social media, and this sharing will become a new source of information to attract other people's attention, thus attracting the attention of more potential consumers. Positive user reviews can further enhance the brand image and market recognition of new energy vehicles, thus increasing consumer trust and attracting more consumers to buy new energy vehicles. At the same time, these reviews also play an important role in the optimization and upgrading of enterprises and the adjustment of business strategies.



*Fig 3. AISAS flow chart*

In the automotive industry, more and more consumers choose to rely on network information and social media to understand the product, Fu Shuai pointed out that car-buying consumers access to automotive information, will be infested with a variety of information, thus making their own access to information, attention is constantly weakened [Jia, J.] so public opinion becomes an important factor for consumers to understand the product, whether it is positive public opinion or negative public opinion, it will affect the consumer's purchasing decisions that affects the sales of new energy vehicles.

From the point of view of consumers' purchase decision, positive reviews can increase consumers' willingness to buy new energy vehicles. Consumers usually refer to various reviews to understand the car. If the evaluations are more positive, they are more likely to choose to buy; conversely, negative evaluations may cause consumers to hesitate or give up buying. In response to these evaluations, Ren Hengxin points out that on the one hand, the study of the factors influencing consumer satisfaction of new energy vehicles can be used to enable automobile enterprises to understand the needs of the target group more clearly, formulate targeted product improvement strategies, and improve product satisfaction, so that the enterprises can seize the opportunities in the fierce market competition [Long, L.]. On the other hand, for consumers, their satisfaction can accurately express their demands for new energy automobile products and services, prompting automobile enterprises to continuously improve and provide products and services that can better meet consumers' needs. Xue Hanxin pointed out that the higher the perceived value of the product for consumers, the more conducive to the formation of positive cognitive and emotional attitudes, the more likely it will produce a willingness to purchase the product [Wang, Y.].

From the perspective of market competition pattern, Bai Mei pointed out that the competitiveness of new energy automobile industry can be studied from the perspectives of market competitiveness, the integrity of the industrial chain, the ability to guarantee public infrastructure facilities, the ability to innovate, and the degree of market openness [Wang, X., & Wang, H.]. However, the influence of public opinion on the market competitiveness of new energy vehicles is neglected, and new energy vehicles that receive good evaluations will increase the share occupied by their brands in the market.

To summarize, the industry public opinion of new energy vehicles is an important factor affecting the development of new energy vehicles, which can effectively promote the development of new energy vehicle field.

## **2. Research Methods**

### **2.1 Research Objects**

This study focuses on the evaluations and public opinions expressed by users on major platforms for the models of six brands that occupy a leading position in China's new energy vehicle market, including Tesla, Xiaomi SU7, BYD, etc., which is taken as the main object of analysis, and a series of research indicators have been carefully selected and a database has been constructed to serve as the basis for subsequent data processing and data analysis. The reason why we chose the top six models in China's new energy vehicle market as the object of research is that these brands and models show a high degree of representativeness in China's new energy vehicle market, and the comments made by the users of various platforms can also reflect the situation of today's new energy vehicle market in a relatively realistic manner.

### **2.2 Data Acquisition and Preprocessing**

This study utilizes data crawling technology to crawl the external public information of each platform. The data mainly comes from crawling a number of mainstream video platforms and professional automotive websites, such as Jitterbug, Bilibili and other major video platforms, as well as automotive home, know the car emperor and other professional automotive information and forum websites. Screening the relevant content on the platform, such as the expectations of new energy vehicles, the use of experience, corrective suggestions, and car sales and the impact of the policy, after the collection of raw data, a rigorous data cleaning work, including the removal of duplicated comments, screening of invalid information, correcting erroneous data, etc., in order to ensure that the data is representative of the availability and authenticity. Finally, the collected data were classified and organized to provide a solid data foundation for our in-depth study of users' public opinion analysis on new energy vehicles.

### 2.3 Data Analysis Methods

The analysis mainly includes two major parts: theoretical foundation and NLP sentiment analysis.

In the theoretical foundation part, through studying the research methods and conclusions of related scholars in the literature review, we refined and summarized the empirical methods suitable for this study, and constructed a new framework for sentiment analysis based on AISAS based on the understanding of theoretical principles and empirical principles.

In the NLP sentiment analysis part, this study mainly uses the use of NLP natural language analysis to specifically analyze the impact on the public opinion orientation of new energy vehicles. Firstly, according to the collected data, import the comments, process the data, construct vocab dictionary mapping, divide the training set and test set, customize the positive and negative corpus for training, and construct the data iterator; next, process the word vectors; thirdly, define the network architecture, and implement AddNorm, ffn; fourthly, it is the stage of root model training, and after defining the various training functions and configuring the parameters, the training begins; finally, sentiment analysis of the documented sentences and their visualization. The prediction is presented here: new energy vehicle models have more negative comments than neutral or positive comments.

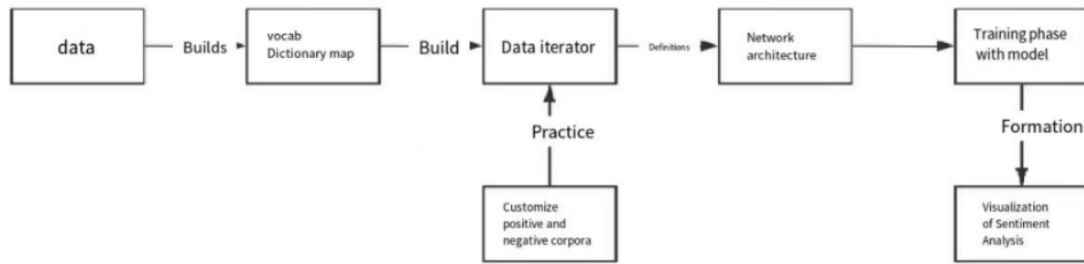

Fig 4. Flowchart of nlp data analysis methodology

### 2.4 Sentiment Distribution Map and Predictive Value Analysis

The study first integrates nearly 60,000 review comments of six models to derive the sentiment distribution map, in which there are 33,277 negative comments, more than half; 19,619 positive comments, accounting for about 30%; and 8,033 neutral comments, accounting for about 15%.

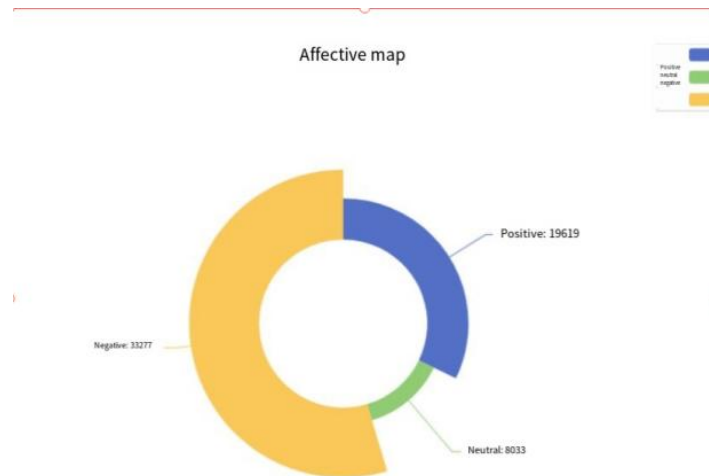

Fig 5. Sentiment distribution map of models after totalization

Here, the predictive value of each review is evaluated by NLP text analytics, and the predictive value of each review indicates the sentiment intensity of the review, and the study sets the range from 0 to 1, where 0 indicates negative sentiment and 1 indicates positive sentiment. Below are the average predictive value statistics for the six major models:

Table 1. Predicted mean values in the sentiment analysis table

Car Models	Ideal L7	Ask the boundary M7	Wuling macrolight	MilletSU7	Tesla	BYD Qin PLUS	overall
Average	0.3675	0.4001	0.3990	0.5895	0.3612	0.3404	0.3991

The results show that, except for Xiaomi SU7 which presents more favorable results, the sentiment prediction mean is 0.5895; all other models are dominated by negative evaluations, and the prediction values are collectively below 0.5 points; there are no models dominated by neutral evaluations in the data results.

## 2.5 Sentiment analysis graph study

In order to better support the above mean values, the study uses NLP text sentiment analysis based on the above review data and at the same time utilizes the sentiment analysis diagram, which can more intuitively show the sentiment scores and distribution of the reviews among the various models.

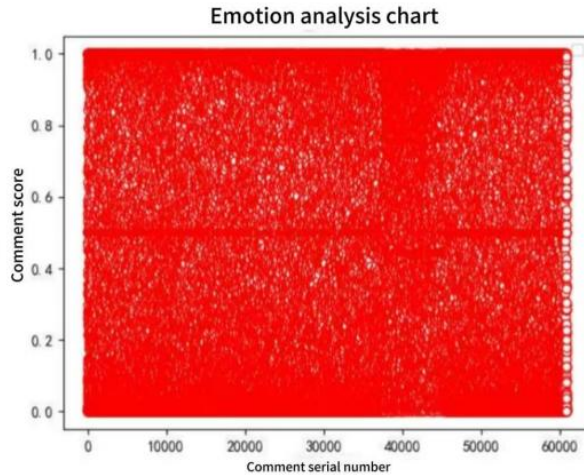

Fig 6. Overall sentiment analysis chart of the reviews of the six major new energy vehicle brands

From a general point of view, the range of positive and negative scores of the six major models is polarized. First, the areas in the figure are almost all dominated by red, and the depth of the color implies the strength of the emotional tendency in the comments. Whether it is a positive or negative comment, the red color suggests that the emotional descriptions of the comments of all types of models are more prominent and obvious. Secondly, by observing the emotional score on the vertical axis, the region with higher score, i.e. the comments with stronger emotional tendency, is mainly distributed in 1.0 more intensively, and with the decrease of the score, the distribution is gradually sparse, and the number of the situation is greatly reduced; similarly, the comments with weaker emotion are mainly concentrated in 0.0-0.2, and the distribution is more intensive, and the number of the proportion of the huge. Again, according to the serial number of the comments on the horizontal axis, it can be seen that there is a certain degree of difference in the emotional score of the comments in different serial number segments.

From the perspective of specific models, the reviews of Ideal L7, Ask M7, Wuling Hongguang, Tesla and BYD Qin PLUS are more in the form of negative and negative.

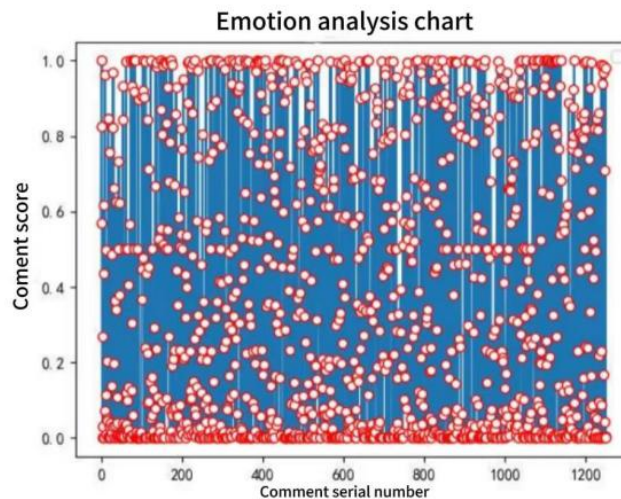

Fig 7. Ideal L7 Sentiment Analysis Chart



As can be seen from the figure, the review score of Ideal L7 is mainly concentrated in 0.0 points, with a more balanced distribution between 0.2-0.6 points, and the strength of emotional tendency is generally lower, so the negative sentiment of the whole evaluation is more obvious.

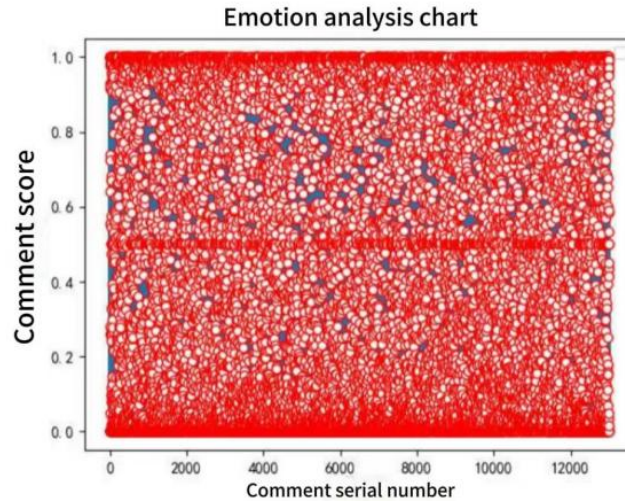

Fig 8. Ask M7 Sentiment Analysis Chart

As can be seen from the figure, the review score of M7 is mainly concentrated in 0.0, 0.5 and 1.0 points, but the color is darker near 0.0 points, and it is worth noting that the blue part of the area in the range of 0.5-0.9 points indicates that the intensity of negative attitudes in this part is relatively large, so that the negative emotions of the whole evaluation are also more obvious.

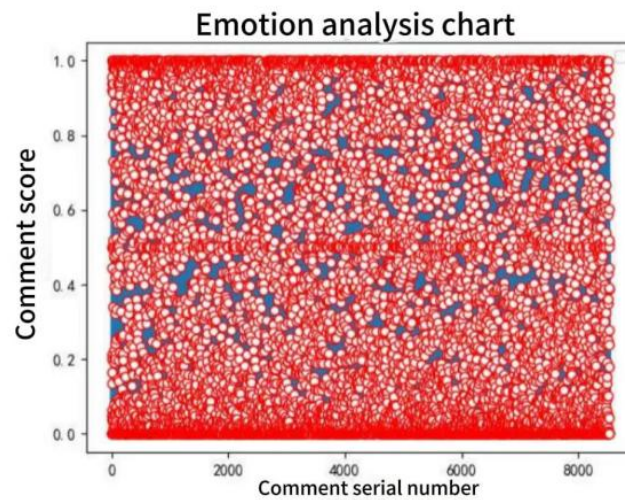

Fig 9. Wuling Hongguang sentiment analysis chart

As can be seen from the figure, the review score of the Wuling Hongguang is mainly concentrated in 0.0 and 1.0 points, more intensive at 0.0, in the blue part of the region of 0.5-0.9 points, the positive and negative review scores are more uniformly pooled, but the review score is generally lower, and the negative evaluation is significantly ahead of the positive evaluation in terms of quantity.

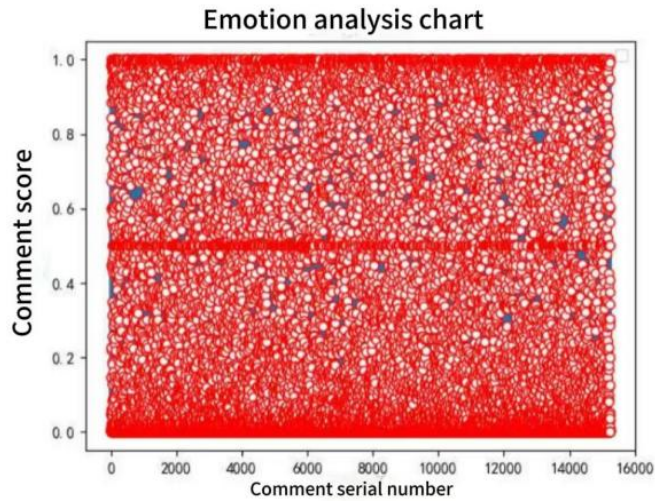

Fig 10. Tesla Sentiment Distribution

As can be seen from the figure, Tesla's comment scores are mainly concentrated in 0.0, 0.5 and 1.0, although there is a certain degree of difference in sentiment, but the overall comment scores are on the low side, i.e., negative comments also dominate.

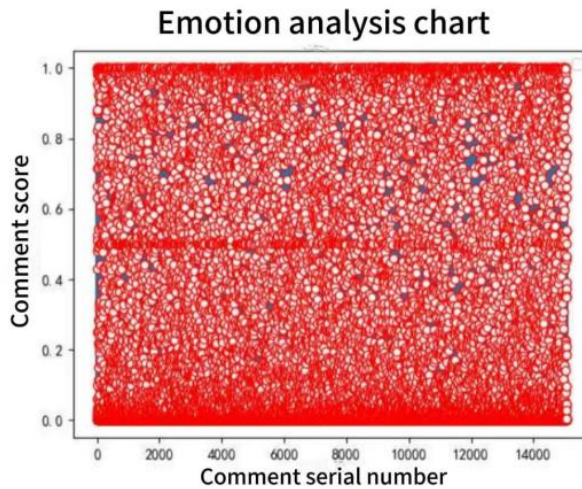

Fig 11. Distribution of BYD's Sentiment

As can be seen from the figure, BYD's emotional score is mainly concentrated in the vicinity of 0.0 points, and this part of the region shows a trend of the lower the score the denser the dots, and in the 0.5-1.0 points among the emotionally inclined comments are less, and most of the comments are still low.

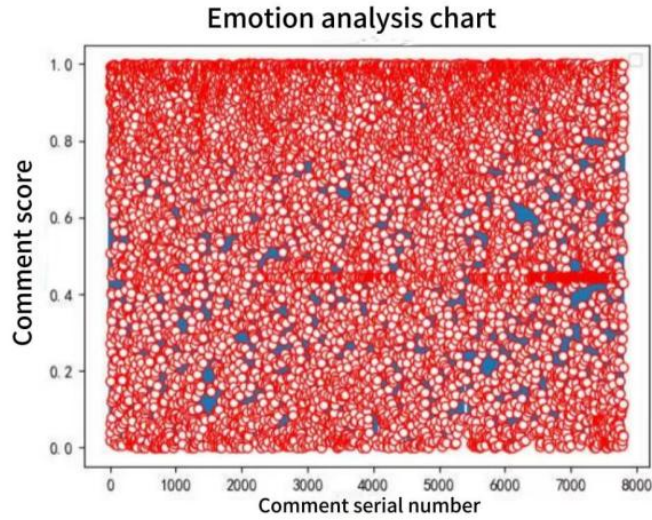

Fig 12. Xiaomi SU7 sentiment analysis chart

Among the six models, the more prominent is Xiaomi SU7, as can be seen from the figure, the positive comments with a higher strength of emotional tendency are mainly concentrated in the vicinity of 1.0, and the number is relatively large, and at the same time, although some of the areas are blue, i.e., the distribution of negative emotions, their emotional scores are lower, and the corresponding emotional performance is weaker, which indicates that the influence of its negative comments is smaller, and the positive comments perform more excellent.

## 2.6 Positive and negative word cloud display under descriptive statistics

Based on the data presented in the first two steps of the research process, the study enters the keyword extraction phase of user feedback analysis, where, through the code, positive and negative emotional comments are first categorized, and then the high-frequency words of the two types of comments are counted, which improves the differentiation of keywords in the user evaluation category while paving the way for the results of the next part of the study.



Fig 13. Word cloud map on positive comments

The above figure represents the keyword extraction under positive comments. From high-frequency to low-frequency, the keywords are: millet, price, range, feeling, smart driving, charging, safety, owner, high speed, new model, automatic, leading.

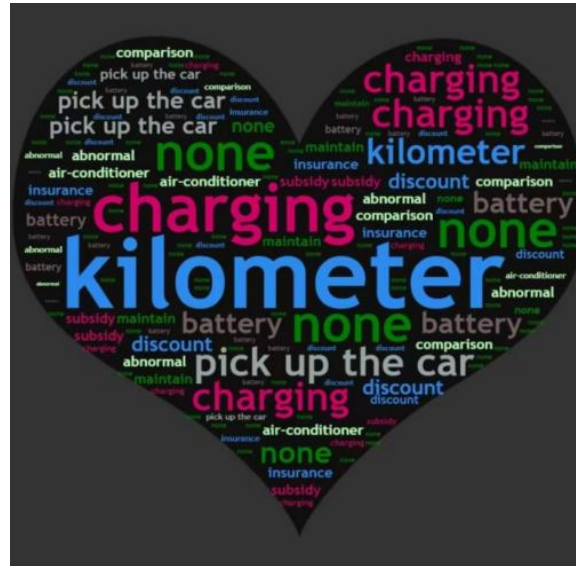

Fig 14. Word cloud map about negative reviews

The above figure represents the keyword extraction under negative reviews. From high-frequency to low-frequency, the keywords are: kilometers, charging, no, pick up, battery, discount, abnormal, maintenance, insurance, comparison, subsidy, air conditioning. These are high-frequency feedback words from users, so they will be highly emphasized later in the elaboration in conjunction with AISAS.

### 3. Results and Discussion

#### 3.1 Research Results

The results of the study reveal some key trends and characteristics in the public opinion of new energy vehicles. First, we found that among the six major new energy vehicle brands, negative comments occupied a high proportion of 55.46%, while positive comments accounted for 30% and neutral comments only 14.55%. The reason for this result may be that some new energy companies neglect to pay attention to customer reviews and focus more on the R&D aspect of the car.

Through NLP text analysis, we evaluated the sentiment intensity of each comment, with the range set between 0 and 1. The results show that, except for the Xiaomi SU7, which has a relatively high sentiment prediction value (0.5895), the sentiment prediction values of all other models are low, indicating that negative comments dominate. This finding echoes the view mentioned in the literature review that consumer support for new energy vehicle products is high, but product support gradually declines due to the influence of negative event online public opinion.

The sentiment analysis graph visualizes the sentiment scores and distribution of the reviews of each model, showing the polarization of the sentiment tendency. The sentiment scores of the reviews of most models are denser at the two ends (0.0 and 1.0), a phenomenon that may be related to the high expectations of consumers for new energy vehicles and the fallout in actual use. As mentioned in the literature review, consumers' willingness to purchase new energy vehicles is influenced by the evaluations of the people around them, which may explain why there is such a clear polarization in the reviews.

We found that the reasons for the high number of negative reviews of new energy vehicles include product cost-effectiveness, comfort, negative review guidance, and false or exaggerated publicity by car companies. This finding is consistent with the literature review that mentions that consumer evaluations of new energy vehicles focus on technological development, policy and market environment analysis, but neglect consumer evaluations of new energy vehicles. The fact that the sales of new energy vehicles have continued to grow despite the large number of negative evaluations may be related to technological innovation, policy promotion, and increased consumer acceptance of the concept of green mobility. This result echoes the rapid development of the new energy vehicle industry mentioned in the literature review, which demonstrates the favorable trend of China's industrial upgrading and the strong resilience of the economy.

Regarding the analysis of the perceived power of automobile enterprises on reviews, the findings show that automobile enterprises do not pay much attention to user reviews, and some of them pay more attention to product research and development innovation and marketing strategies, while neglecting the importance of user reviews. This finding is in line with the literature review that public opinion, as an external factor in the development of new energy vehicles, can help new energy vehicle enterprises decide their production behaviors according to their own cost-benefit as well as in combination with the market economy and regulatory environment. These findings not only theoretically enrich the research literature on new energy vehicles in terms of public opinion, but also practically provide new perspectives and theoretical structures for the study of public opinion in the field of new energy vehicles, which helps to realize the purpose of improving customer satisfaction.

### **3.2 Problem Findings**

In terms of the negative evaluation of new energy vehicle models, we found that in the negative evaluation of the highest percentage of kilometers, charging, no, pick up the car, battery, preferential, abnormal. The reason for the higher percentage is first of all the product cost-effective, some brands such as: Wuling Hongguang, some consumers pointed out that the battery range is not high, the degree of convenience of charging is not high, consumers are more willing to filter out the more excellent one in the same category, even if there are models in this regard there are no defects, but due to the lack of salient points, greatly reducing the user's expectations, easy to let the user to produce a negative evaluation. In the new energy vehicles of the older brands, before the sales discount is not strong, and the national policy also has a certain connection. Secondly, in terms of comfort, some brands have improved the user's experience to a certain extent by improving technology, but due to the cost or configuration is unreasonable, resulting in the original comfort received weakened. Then in the original negative comments on the guidance, because consumers pay more attention to the negative evaluation, so easy to produce doubts in the personal trade-offs, ultimately leading to distrust of their own models, etc., and part of the car companies do exist false, exaggerated publicity, consumers can not identify the real situation, resulting in the final evaluation of the more ambiguous, more negative attitudes.

In terms of sales, the reason why they bear a lot of negative comments on the basis of still showing better sales, because of scientific and technological innovation, especially in the core technology continues to optimize, in the user to create an advanced and intelligent atmosphere, enhance the attraction of consumers. Policy promotion, China's current efforts to promote green development, especially in the field of new energy vehicles as a strategic focus, such as financial support for car companies, user consumption subsidies, to promote the publicity of the document, to promote the development of new energy vehicles market, although many people's comments are more negative, but personalized emotional tendency to influence and national policy guidance compared to appear relatively small, the final direction of development is also the general trend. But in general, this also reflects the car companies based on user reviews of the perceived strength of very different.

In terms of the degree of importance that car companies attach to user reviews, some car companies pay more attention to product development and innovation, and the long-term development of market strategies, while ignoring the importance of user reviews. At the same time, the instability of the positive and negative orientations of the reviews and the inconsistency of the feedback channels of the reviews have greatly reduced the efficiency of the comprehensive analysis of the reviews by the automobile enterprises.

### 3.3 Research Recommendations

Based on the above analysis, after comment comparison, the reason why the predicted value in the sentiment analysis table of the example millet SU7 is higher is because the appearance of millet SU7 is more in line with the aesthetics of contemporary young people, but also because millet SU7 gives customers more choices in vehicle configuration, can customize the car configuration, and aesthetic diversity. In terms of price, the pricing is reasonable, and before the release of the Xiaomi car, the heat is also higher. Therefore, the new energy automobile industry can satisfy consumers more in terms of personalized configurations, improving comfort, appearance conditions, and cost-effectiveness. Communication with customers is also vital, can not only focus on innovation and research and development, but also need to establish contact with consumers, strengthen the after-sales service, according to the suggestions provided by the customer, change or give a reply, which is conducive to the connection between customers and customers, customers and manufacturers, which can largely increase the customer's desire to buy, and then enhance the brand sales. According to the problems found above, car companies can take the following measures:

Enhance the outstanding features of the product, car companies can deeply understand the needs of consumers, through technological innovation and cost optimization, to improve the cost-effectiveness of the product, to find and highlight their own unique selling points, so as to enhance the user's expectations and satisfaction; optimize the comfort and configuration, increase the R & D investment in comfort to ensure that the configuration of the reasonableness of the configuration, to avoid excessive stacking in order to enhance the user's experience; actively respond to the negative evaluations, and the official and timely response to the consumers' concerns and dissatisfaction. For false and exaggerated publicity, it should be corrected to ensure the authenticity of the publicity content; pay attention to user comments and feedback, car companies can increase the importance of user comments on the platform, incorporate them into the reference scope of product improvement, respond positively and take measures to solve the problem, and enhance the user's trust in the brand.

According to the AISAS model, to improve the big data marketing ability, it is suggested that the new energy automobile industry can first increase the publicity; show the advantages of the product to arouse the interest of consumers; after the customers are attracted, it will be easier to turn the potential users into consumers and search for the product; improve the product performance, it is easier to choose to take action to buy after the customers have finished their searches; the enterprises can do a good job of communicating with the customers, and it is easier for the consumers to put the brand on the market with good service attitude. Good service attitude is more likely to let consumers recommend the product to others.

## 4. Conclusion

Through empirical analysis, this paper reveals the main problems and trends in the public opinion of new energy vehicles. Despite the fact that new energy vehicles face many negative comments, their sales continue to grow, which indicates that the market demand for new energy vehicles is strong and positively influenced by policies and technological innovations. However, car companies' insufficient perception of and response to user reviews may affect brand image and market competitiveness. Therefore, it is recommended that vehicle companies should pay more attention to consumers' voices and enhance product cost-effectiveness and comfort through technological improvements and innovations, as well as strengthen communication with consumers in order to improve customer satisfaction and market competitiveness. In addition, policy makers should also continue to support the development of the new energy vehicle industry and promote the healthy development of the industry through policy guidance and market incentives. On this basis, the research in this paper not only theoretically enriches the research literature on new energy vehicles in terms of public opinion, but also provides a way to quantify the trend of public opinion by analyzing the emotional tendency of the comment data of online users with the help of network data collection technology and NLP natural language processing technology.

## 5. References

- Bai, M. (2020). Study on the competitive pattern of global new energy vehicle industry. *Price Theory and Practice*, (01), 25–31.
- Chen, J. (2024). Influence and analysis of new media marketing on consumer purchase decision. *Old Brand Marketing*.
- Chen, S. (2024). Application of NLP technology in enterprise procurement management under the background of big data. *China Logistics and Purchasing*.
- Fang, F. (2024). Analysis of enterprise marketing strategy in the era of big data. *Market Outlook*, (10), 23–25.
- Fu, S. (2024). Analysis of commercial realization path of automotive new media based on AISAS model. *World Automobile*, (05), 46–49.
- Han, M. (2022). Research on marketing strategy of M leisure food company under the perspective of consumer behavior [Master's thesis, Henan University].
- Hou, H. (2024). Analysis of new energy vehicle user reviews based on sentiment analysis and topic extraction [Master's thesis, Shanghai Normal University].
- Jia, G. (2023). Research on aspect sentiment analysis based on deep learning method [Master's thesis, Jilin University].
- Jia, J. (2021). Research on the influence of product description page layout on consumers' attention, memory, and preference [Master's thesis, Southwest Jiaotong University].
- Long, L. (2023). Influence of consumers' pre-purchase information search behavior on the selection of sales model on manufacturer platforms [Master's thesis, Southwest Jiaotong University].
- Ren, H. (2023). Research on new energy vehicle product satisfaction enhancement strategy based on online reviews [Master's thesis, Chongqing University of Commerce and Industry].
- Song, C. (2024). Research on the behavioral characteristics and sentiment analysis of new energy vehicle consumers based on text mining [Master's thesis, Guizhou University].
- Wang, X., & Wang, H. (2024). Research on brand reputation evaluation system of automobile measurement under the perspective of AISAS model. *Modern Business*, (15), 7–10.
- Wang, Y. (2014). The impact of mass media communication exposure on consumption. *China Media Science and Technology*.
- Xue, H. (2023). Research on the influence mechanism of perceived product innovation on the purchase intention of new energy vehicles. *Journal of China University of Petroleum (Social Science Edition)*, 39(06), 84–91.